

INSTRUCTION MANUAL

DCS-0.5T Digital Crane Scale 500kg / 1102LB Capacity



C190

Content

<u>1. Safety Guide</u>	1
<u>2. Features</u>	1
<u>3. Specifications</u>	2
<u>4. Capacity</u>	2
<u>5. Dimension & Weight</u>	3
<u>6. Display & Keys</u>	4
Scale Keys.....	4
Indicators.....	4
Message.....	4
<u>7. Operations</u>	5
Power On/Off.....	5
Zero.....	5
Tare In/Out.....	6
Lock/Unlock.....	6
Unit Switch.....	6
<u>8. User Setup</u>	6
Auto-Off Timing.....	6
Backlight Brightness.....	7
Idle Mode Timing.....	7
<u>9. Battery Maintenance</u>	8
<u>10. Troubleshooting</u>	8

Version: V1.0A-1

Please read this manual carefully before using.

1. Safety Guide

For good performance and precise measurement, be careful with daily operation and maintenance.

- i** Do NOT overload scale. This will damage loadcell and void warranty.
- i** Do NOT leave load hung on the scale for long. This will decrease scale's accuracy and shorten loadcell's life.
- i** Inspect shackle and hook before using. Check clips, pins and screws regularly.
- i** Check battery frequently. When scale runs out of power, replace the dead batteries with new ones.
- i** Rotate load rather than scale if needed.
- i** Do NOT use scale under thunder or rain.
- i** Hang scale on shelf in dry and well-ventilated room. Do NOT place scale on the ground directly.
- i** Do NOT attempt to repair scale yourself. Contact your local representative.

2. Features

This scale is a combination of sound and proven mechanical design, with today's most advanced electronics to provide a superb feature set. It is versatile, reliable, accurate and easy to operate.

- Superb Quality.** Strictly in accordance with OIML R76, Chinese GB/T11883-2002 national standards, and European CE directives.
- Great Safety.** Aluminum-casting case, high firm hook and

shackle, dedicated weighing load cell for safety installation.

- Strong Reliability.** Cutting-edge technology, quality integrated circuit for high performance and long-time stability.
- Broad Applicability.** Popular and applicable in storage, textile, metallurgy industry, and so forth.
- Complete Function.** Resolution switch, unit conversion, auto power-off, battery inspection, etc.

3. Specifications

Accuracy	Chinese GB/T 11883-2002 CIII eqv. OIML R76
Tare Range	100% F.S.
Zero Range	4% F.S.
Stable Time	≤10sec
Overload	100% F.S. + 9e
Safety Load	120% F.S.
Ultimate Load	400% F.S.
Battery	3*AA 1.5V batteries.
Battery Life	≥65hour (tested by dedicated batteries, backlight level 3, always lit)
Display	22mm/11mm HTN LCD with backlight
Op. Temp.	-10℃ ~ +40℃
Op. Humidity	20℃ ≤90%

4. Capacity

Modal	Max. Cap.	Min. Cap.	Res.	Division
OCS-01-S	100kg	1kg	0.05kg	2,000
OCS-02-S	200kg	2kg	0.1kg	2,000
OCS-03-S	300kg	2kg	0.1kg	3,000

OCS-05-S	500kg	4kg	0.2kg	2,500
OCS-1-S	1,000kg	10kg	0.5kg	2,000

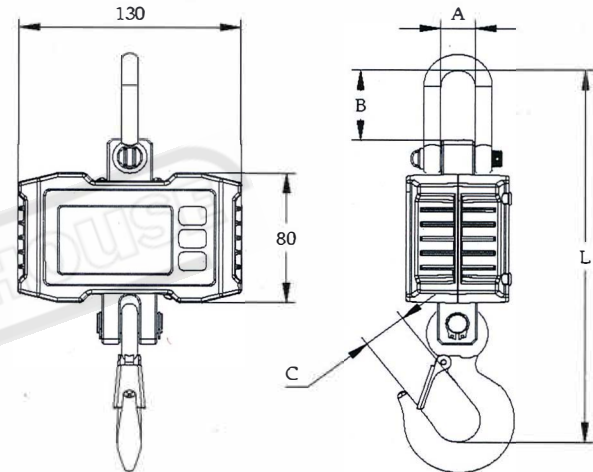

5. Dimension & Weight









Modal	A/mm	B/mm	C/mm	L/mm	N.W./kg
OCS-01-S	20	43	25	220	1.0
OCS-02-S	20	43	25	220	1.0
OCS-03-S	20	43	25	220	1.0
OCS-05-S	20	43	25	220	1.0
OCS-1-S	20	43	27	230	1.4

6. Display & Keys

Scale Keys







Key	Name	Function
	On/Off	Short pressing: Cancel & return to weighing mode Long pressing: Power-on / Power-off
	Tare	Short pressing: Tare in/out; Increase digit Long pressing: Zero; Move digit
	Hold	Short pressing: Lock/unlock; Confirm & next Long pressing: Unit Switch; Input / cancel decimal point

Indicators

LED	Name	Note
	Stable	shown when weight is stable
	Zero	shown when weight is at zero
	Tared	shown when scale is tared
	Hold	shown when scale is locked
	lb	shown when unit is lb
	kg	shown when unit is kg
	UN	shown when unit is User Unit

Message

Message	Stand for	Note
-----		detect weight

	SETUP	User Setup Menu
	BATtery	battery life percentage
	END	save and exit
	OFF	power off
	OVERload	overloading
	ERRor	invalid operation

7. Operations

Power On/Off

- ✓ Press  for 1s to power-on scale. Scale perform initialization and power-on test, **88888** shows twice, then capacity **1000** shows, battery life percentage **bAttery** shows, weight detection ----- shows and then auto zero.

↪ For information about Auto-Zero, refer to Scale Configuration in Technical Manual.

- ✓ Press  for 1s to power-off scale. Battery life percentage **bAttery** shows, off message **oFF** shows, and then cut off power.



↪ When 3 batteries voltage is lower than 3.2V, scale will auto power-off itself. Please replace the dead batteries with new ones.

Zero



- ✓ Press  for 1s to zero. **0** shows.
- ⓘ If load is in motion, or tared, or out of Manual-Zero Range, **Err** shows.

↪ For information about Manual-Zero Range, refer to Scale Configuration in Technical Manual.

Tare In/Out

- In gross mode, press  to tare in. **T** shows.
- If load is in motion, or negative, or out of Tare Range, **Err** shows.
- Tare will reduce the apparent overload range of scale. For example, if a 500*0.2kg scale has a 100kg container as its tare, the scale will overload at a new weight of 401.8kg (500 - 100 + additional 9 divisions).
- In net mode, press  to tare out. **T** disappears.



Lock/Unlock

- Press  to lock screen. **H** shows.
- Press  to unlock screen. **H** disappears.



Unit Switch

- Press  for 1s to switch unit in between kg, lb, and User Unit.
- When unit is kg, **KG** shows. When unit is lb, **LB** shows. When unit is User unit, **UN** shows.
- For more information about User Unit, refer to Scale Configuration in Technical Manual.

8. User Setup



- Press  and  at the same time for 1s to enter User Setup menu. **SETUP** shows.

Auto-Off Timing



- Press  to enter Auto-Off Timing. **off--** shows.
- Press  to change timing value.

- Auto-Off Timing can be set to: **0** (disabled), **5** (5min), **10** (10min), **15** (15min), **30** (30min), **60** (60min). It is disabled by default.
- Auto-Off function maximizes scale's battery life against people's carelessness not to power off scale when it's not working.
- Auto-Off starts countdown timer when there's no action or load is stable. Any key pressing or motion in load restarts countdown timer.

Backlight Brightness

- Press  to enter Backlight Brightness. **br -** shows.
- Press  to change brightness value.
- Backlight Brightness can be set to: **off** (disabled), **1** (dim), **2** (normal), **3** (bright).
- Dim backlight brightness saves battery power dramatically.

Idle Mode Timing

- Press  to enter Idle Mode Timing. **IDL--** shows.
- Press  to change timing value.
- Idle Mode Timing can be set to: **0** (disabled), **5** (5sec), **10** (10sec), **15** (15sec), **30** (30sec), **60** (60sec). It is 30sec by default.
- To maximize battery life, scale automatically enters Idle Mode, when there's no action or the load is stable. In Idle Mode, scale works in low-power consumption status. Any key pressing or motion in load wakes up scale from Idle Mode.
- Press  to exit User Setup.

9. Battery Maintenance

To maximize battery life, please note the following battery maintenance guide.

- ① This scale is powered by a 3 AA 1.5V batteries.
- ① Battery house can be opened by screwing off 2 screws.
- ① Depending on backlight brightness and idle mode setting, normally, battery works over 65 hours.
- ① In order to conserve battery life, enable Auto-Off and Idle Mode, dim backlight brightness.
- ① To obtain maximum service life, battery should be stored between -20°C (-4° F) and +50°C (122° F). Stored batteries should be recharged every three months.
- ① When 3 batteries voltage is lower than 3.2V, scale will auto power-off itself. Please replace the dead batteries with new ones.

10. Troubleshooting

Simple problems can be resolved as below listed solution. If problems still exist, please contact your local representative.

Symptom	Possible Cause	Suggested Solution
not power-on after  is pressed	discharged / defective battery	check battery and replace
	defective On/Off key	press harder and keep pressing for 2s
	defective power cable	open front panel, check power cable

	defective mainboard	contact representative
backlight flashes	discharged battery	replace battery
no action taken after key pressed	scale is disturbed	re-plug power cable
	defective key	contact representative
weight reading not stable	load in motion	keep load stable
	weak Anti-Motion	change Anti-Motion level
	damped loadcell or mainboard	dry loadcell or mainboard
weight reading not zero when no load	defective mainboard	contact representative
	discharged battery	replace battery
	load-cell stressed too long	hang scale in storage
large error in weight reading	loadcell drifts	contact representative
	scale not zeroed before applying load	Manual Zero scale before loading
	wrong unit	switch to correct unit
	scale requires calibration	calibrate scale
	defective loadcell or mainboard	contact representative